

Article number: 204350M840D0SK
 Description: E+G levelling foot
 GN 43-50-M8-40-D0-SK
 Note: SK With nut, External hexagon at the bottom

Measures

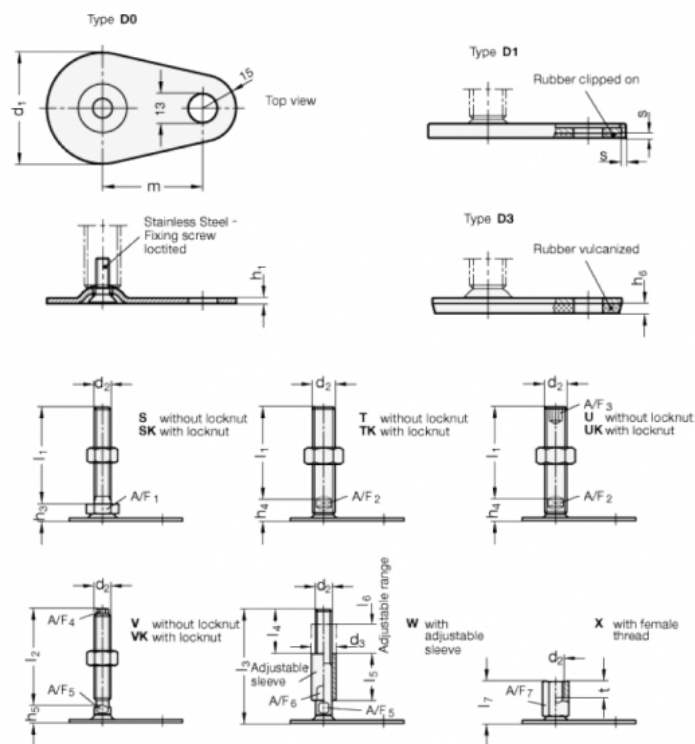

A/F1 = 17	s =
d1 = 50	
d2 = M8	
h1 = 2.5	
h3 = 11	
h6 =	
l1 = 40	
m = 45	